

+ F6

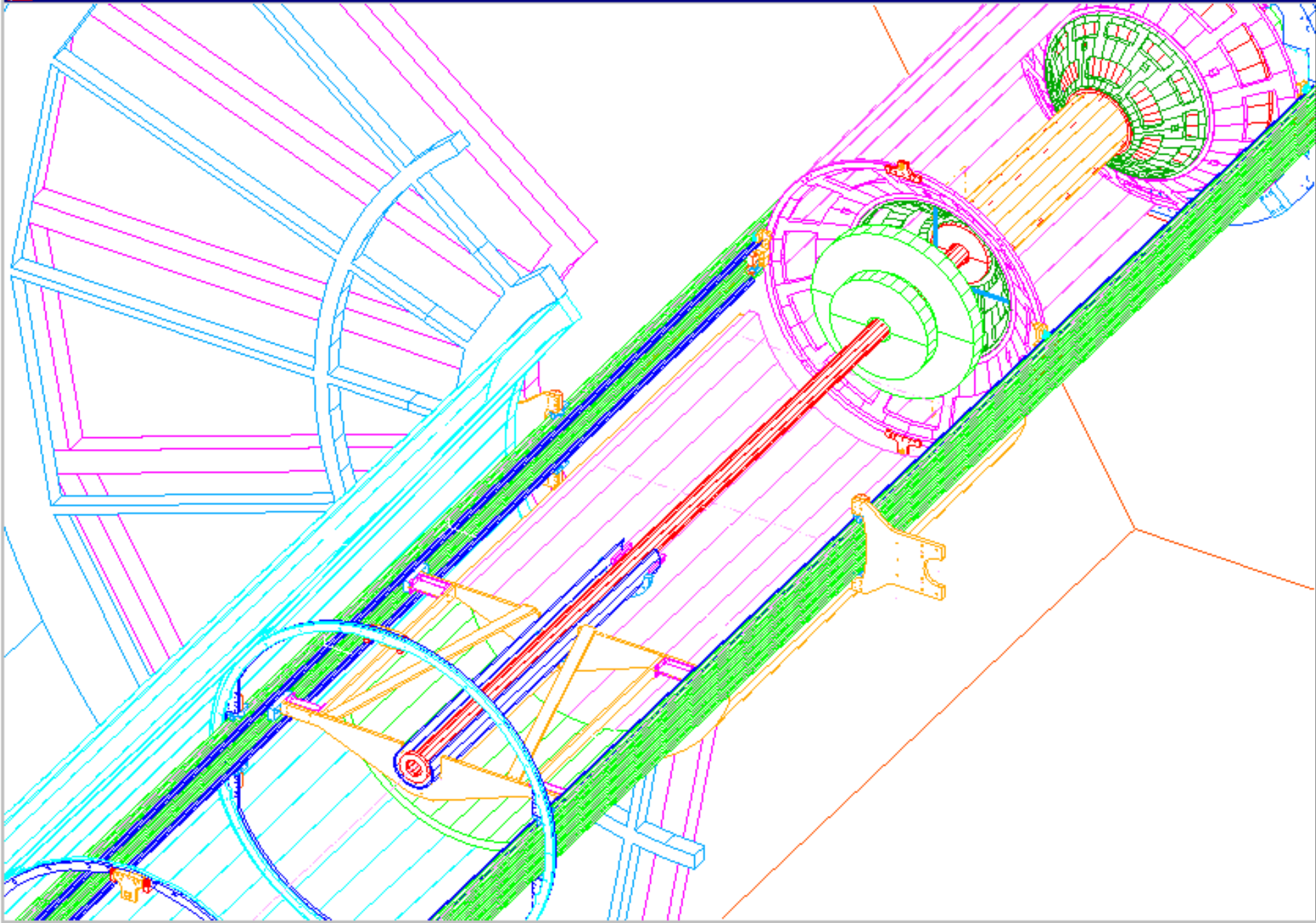

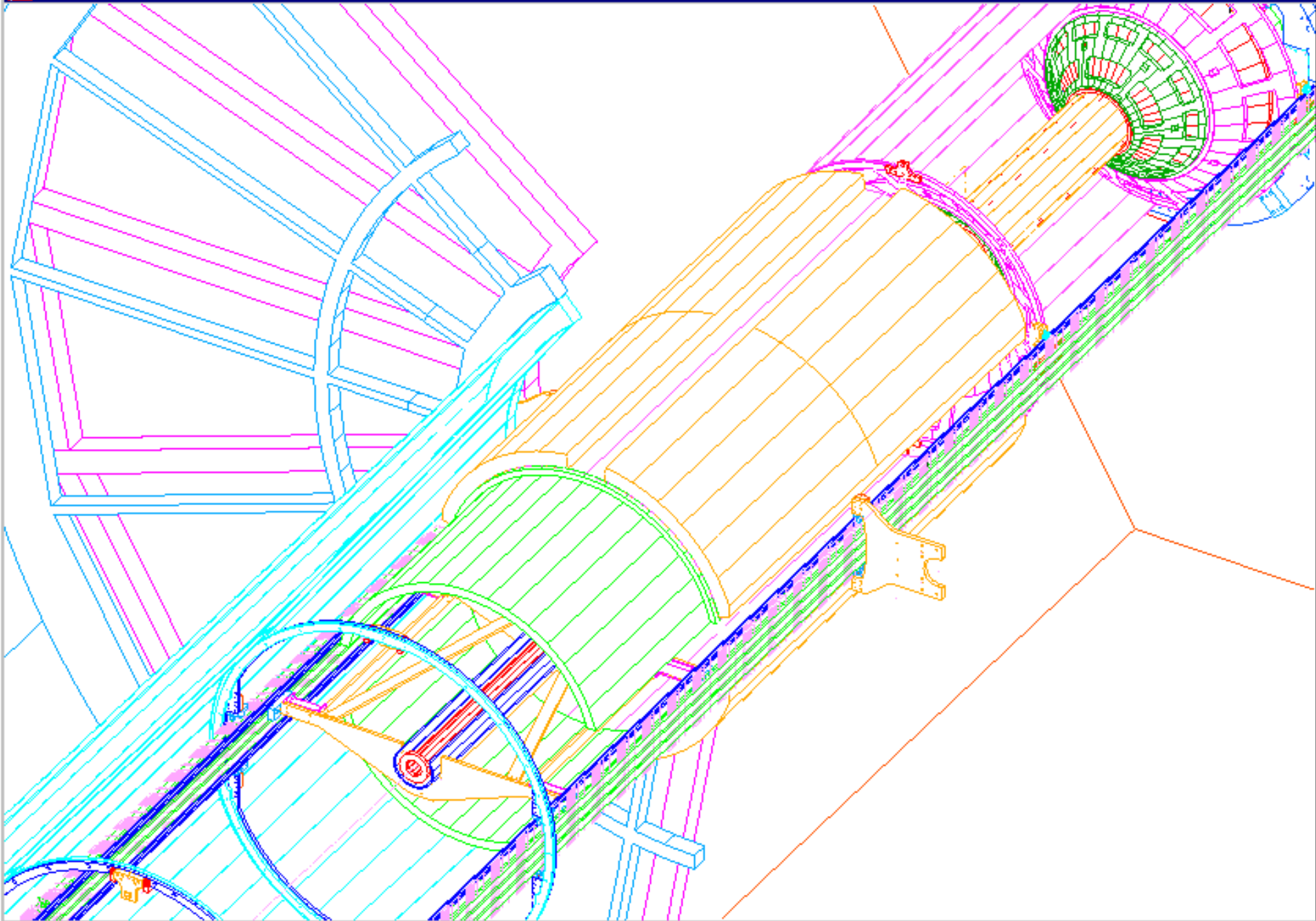

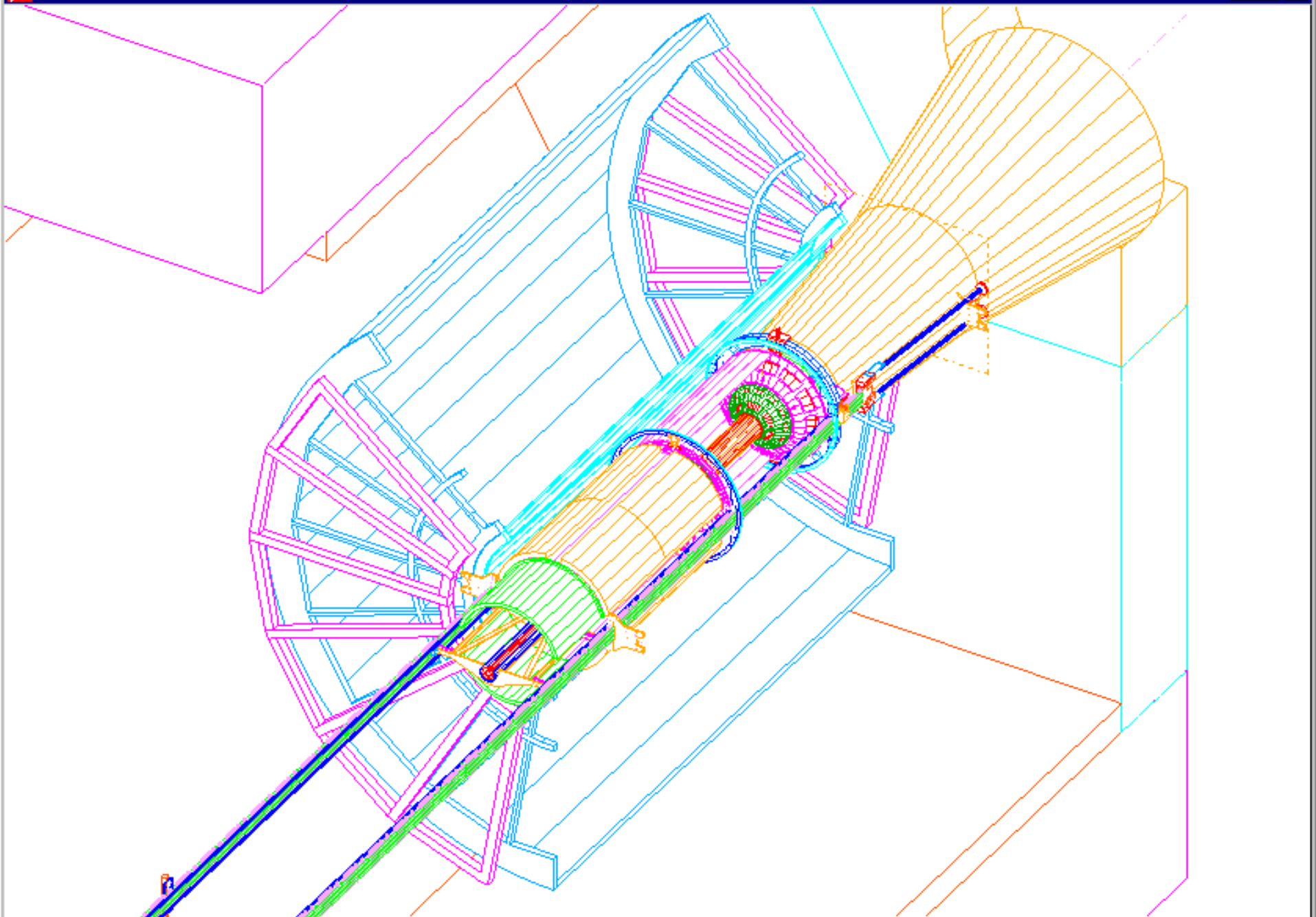

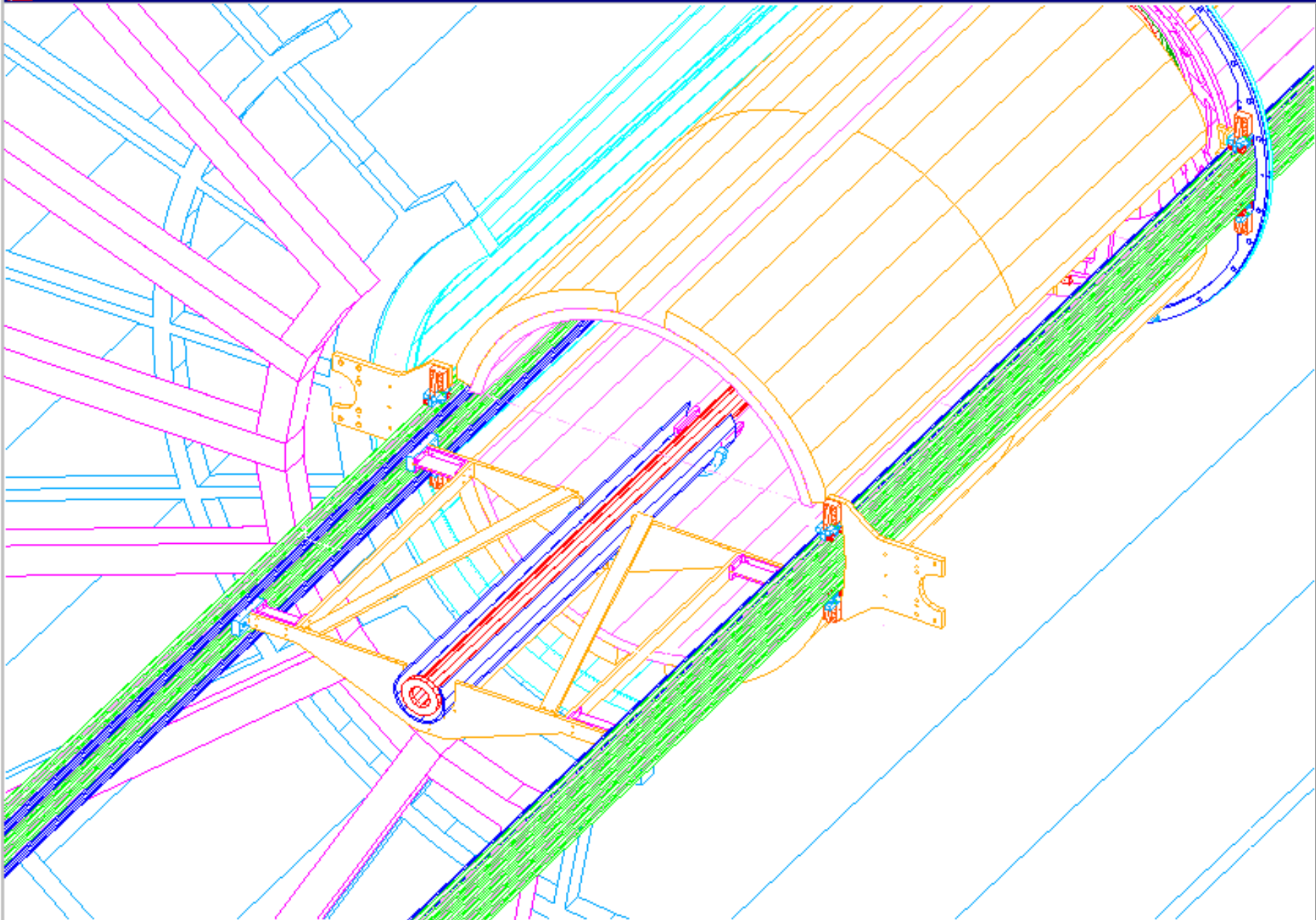

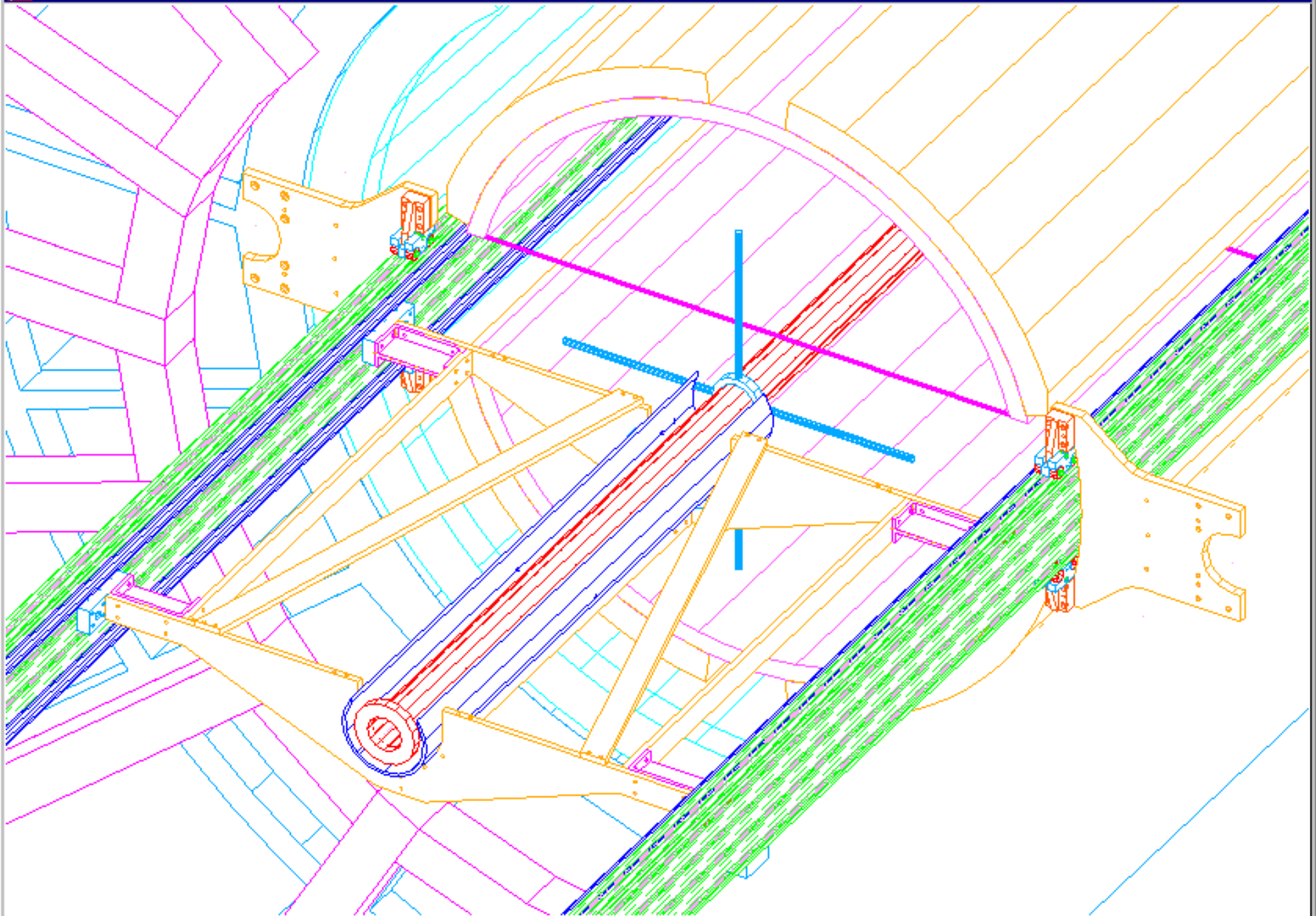

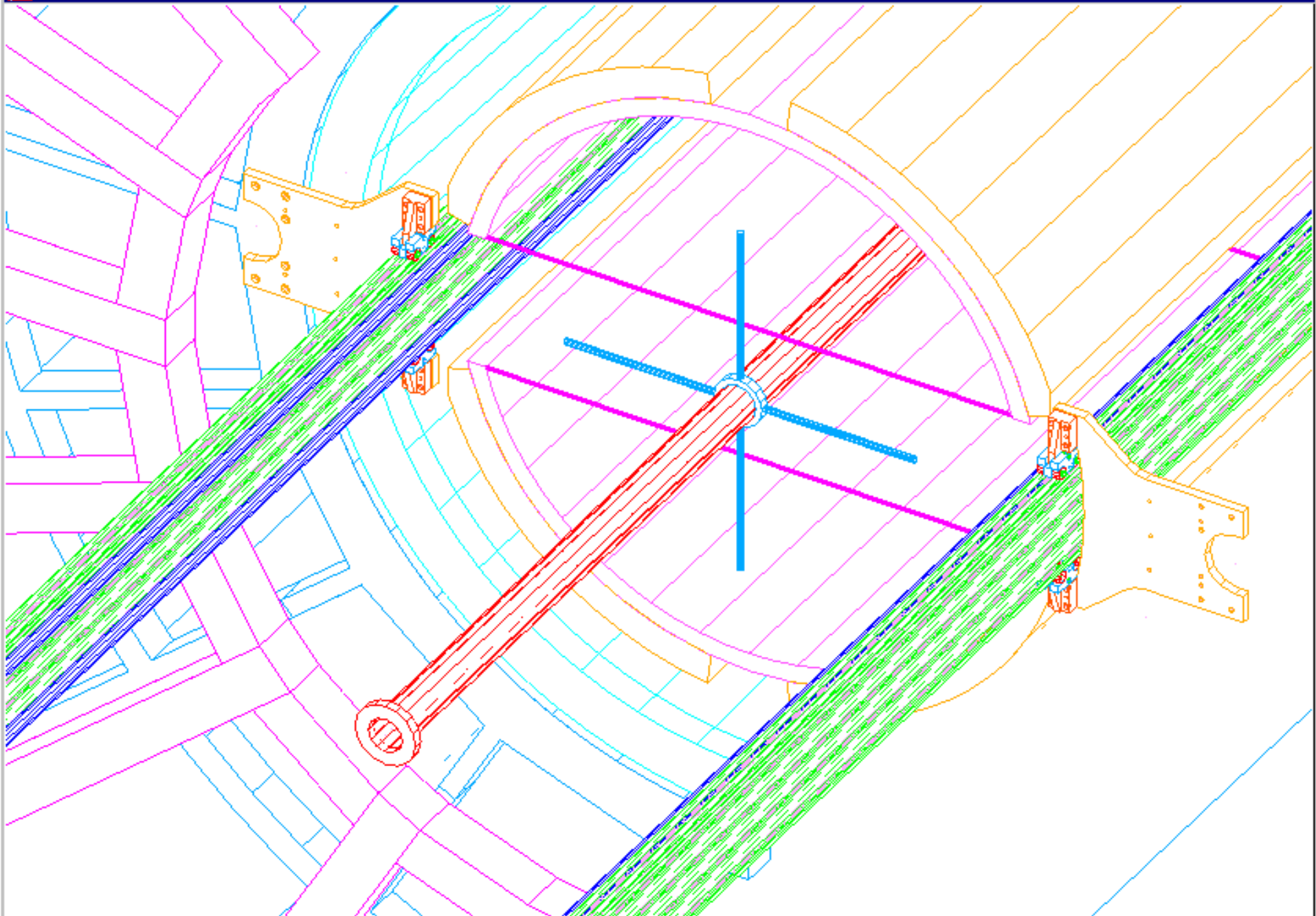

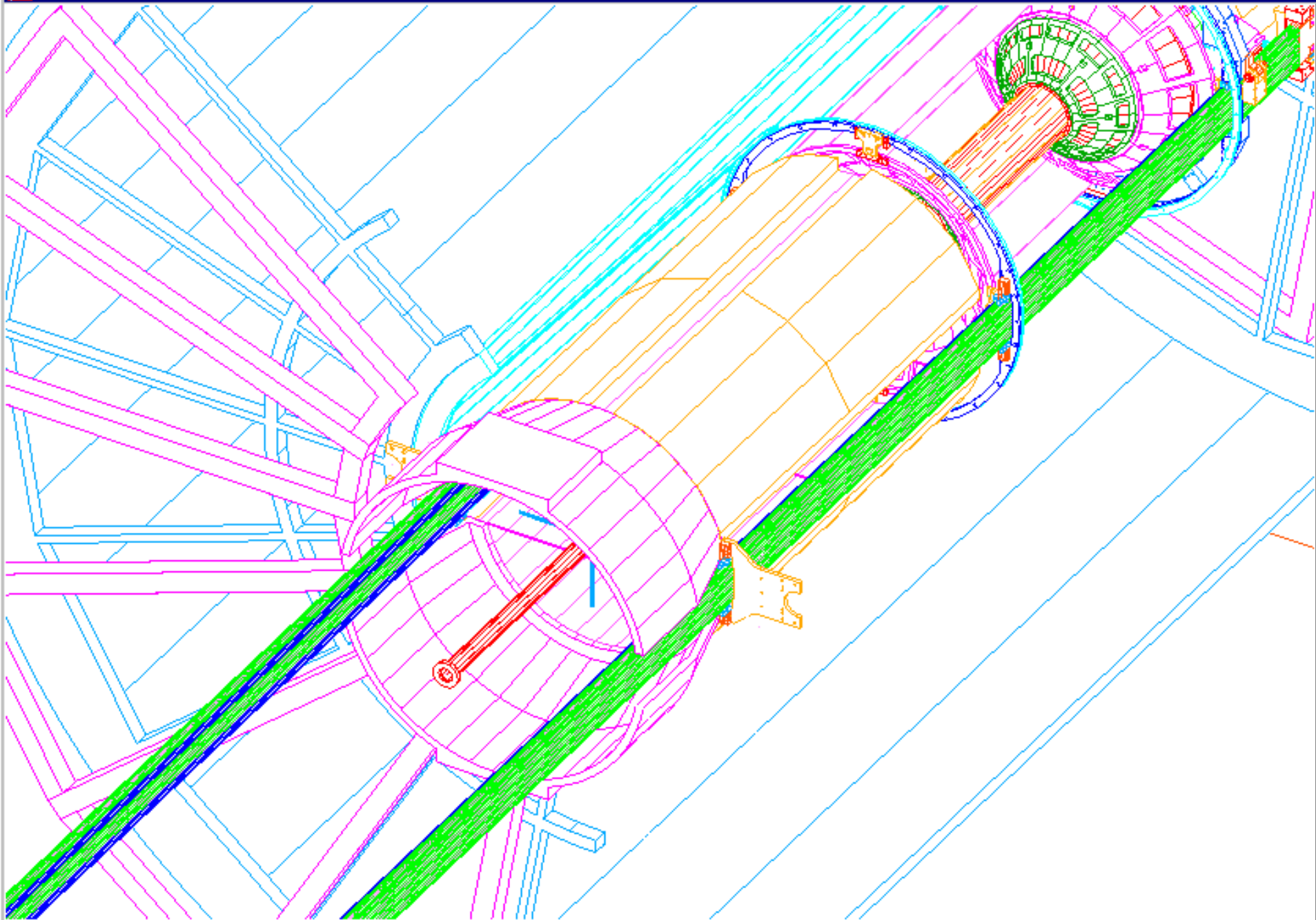

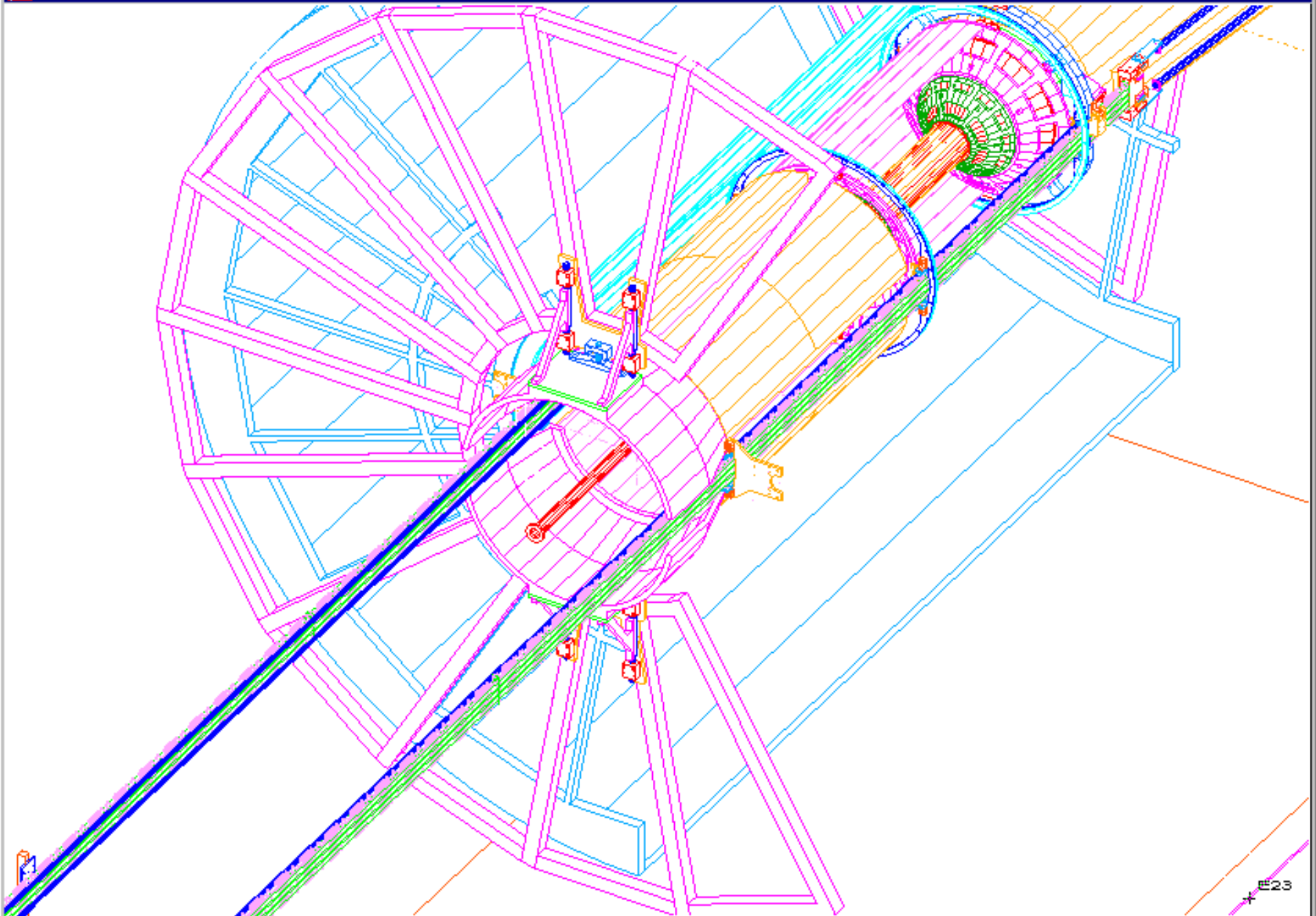

E23

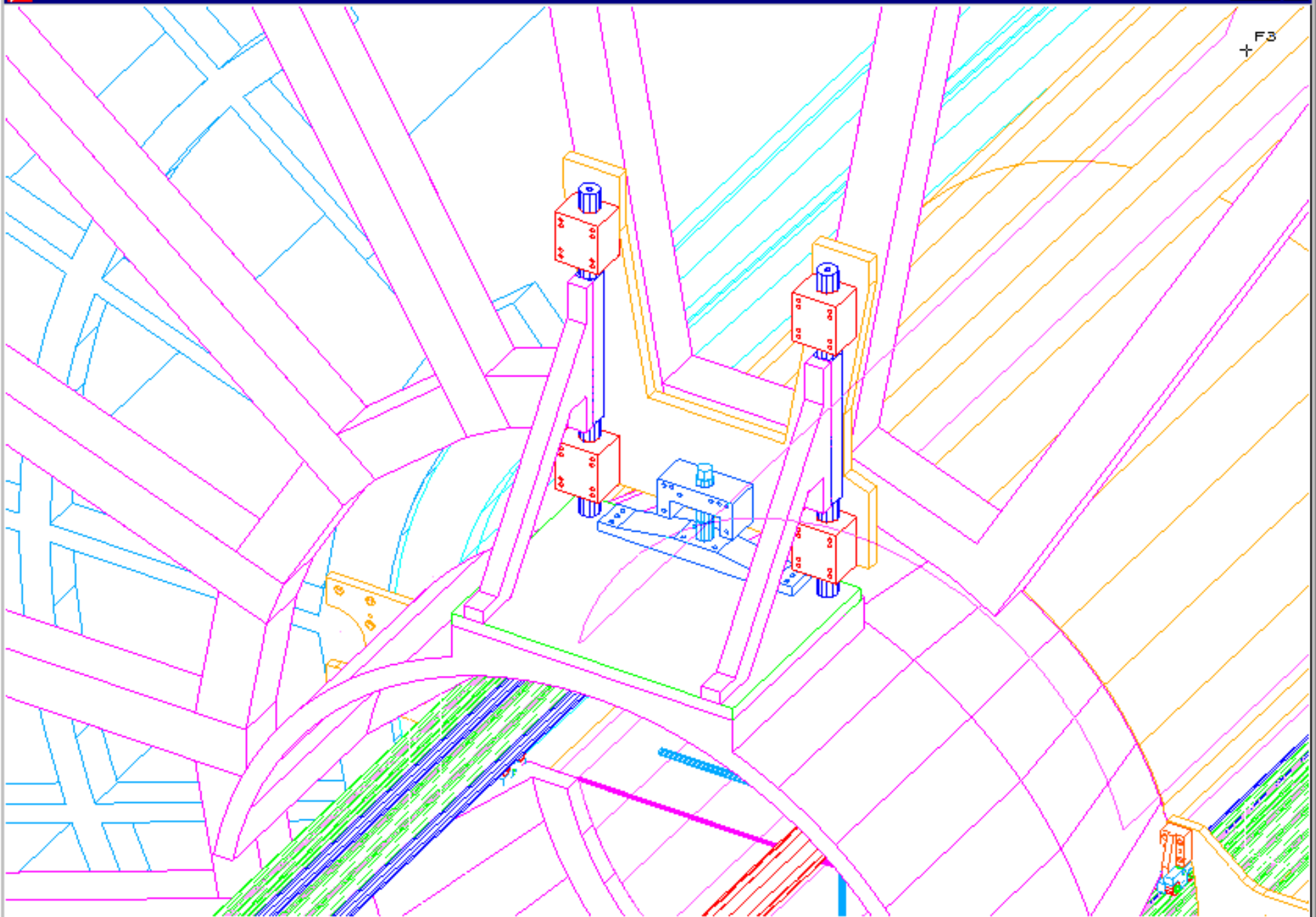

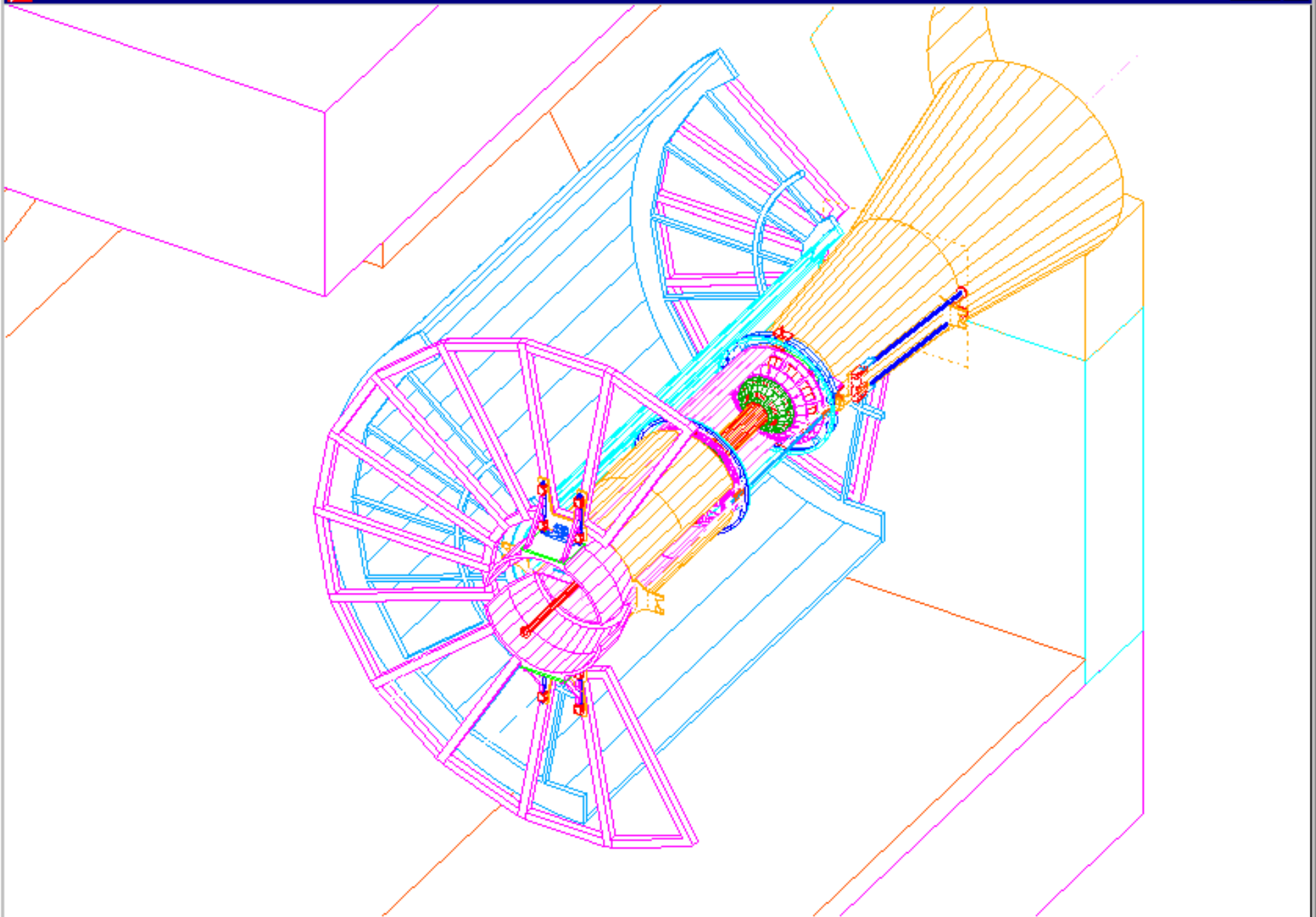

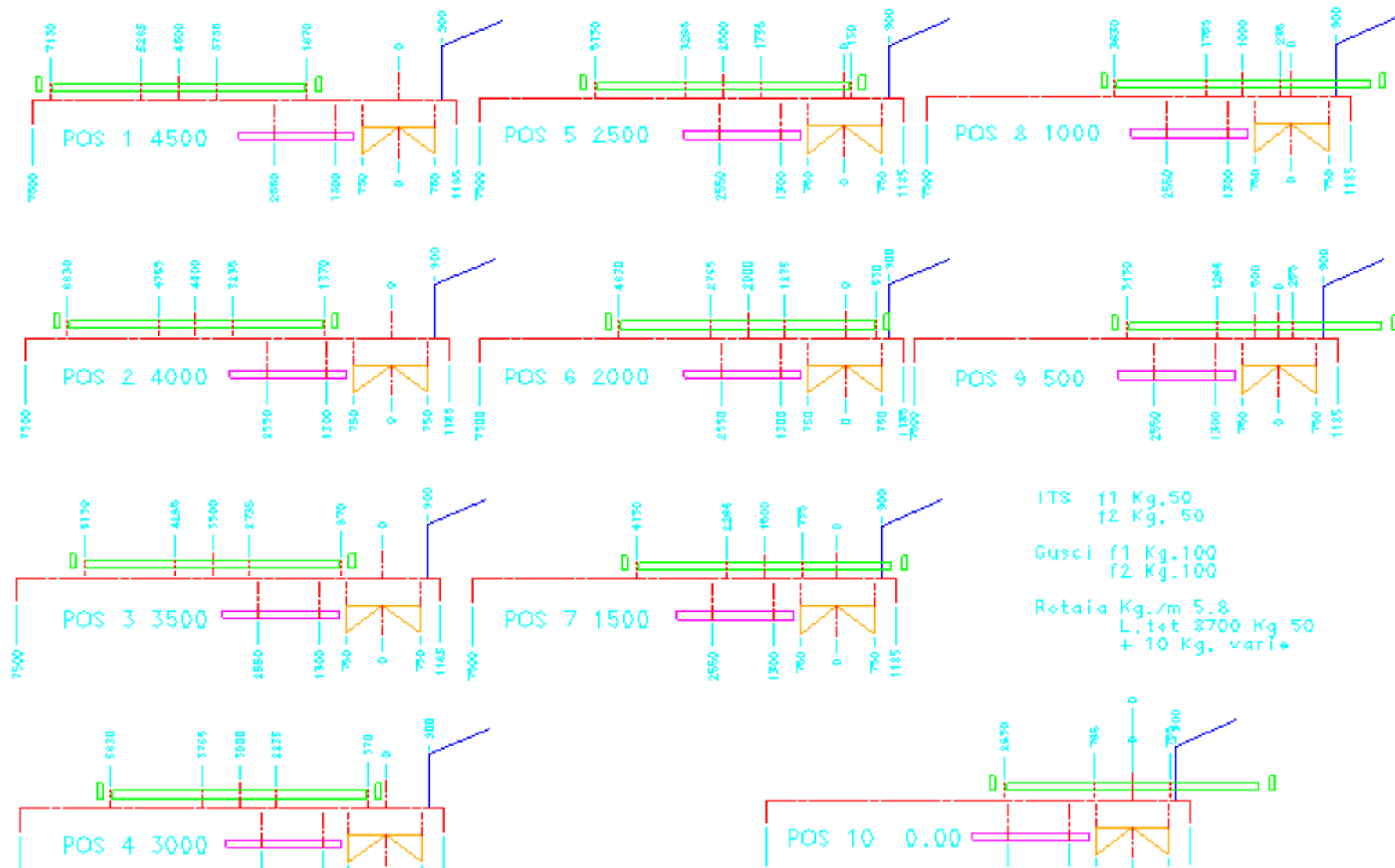

- ITS f1 Kg. 50
f2 Kg. 50
- Gusci f1 Kg. 100
f2 Kg. 100
- Retaila Kg./m 5.8
L. f. 1st 3700 Kg. 50
+ 10 Kg. varia